

## Ceiling Switches

### Standards and approvals

3164 WHI fully complies with the 16th Edition Wiring Regulations (BS 7671) with respect to safety isolation for maintenance purpose. Conforms to BS 3679: 1989

3190 WHI, 3191 WHI, 3192 WHI, 3131 WHI, 2051 WHI, 2056 WHI, conform to BS EN 60669-1: 1996

3151 WHI conforms to BS EN 60669-1: 2000

### Technical specification

#### Electrical

Voltage rating:  
250V a.c.

Maximum rating:  
See range details

Note: Switches do not have to be derated when used with resistive or fluorescent loads

Terminal capacity:

3131, 3190, 3191, 3192:

4 x 1.0mm<sup>2</sup>  
3 x 1.5mm<sup>2</sup>

3151,  
4 x 2.5mm<sup>2</sup>  
2 x 4.0mm<sup>2</sup>  
1 x 6mm<sup>2</sup>

3164,  
4 x 4mm<sup>2</sup>  
3 x 6mm<sup>2</sup>  
1 x 10mm<sup>2</sup>  
1 x 16mm<sup>2</sup>

2051/2056, Earth Terminal

6 x 1mm<sup>2</sup>  
4 x 1.5mm<sup>2</sup>  
2 x 2.5mm<sup>2</sup>  
1 x 4mm<sup>2</sup>  
1 x 6mm<sup>2</sup>

#### Physical

Ambient operating temperature:  
-5°C to +40°C  
(the average value over 24 hrs not exceeding 25°C)

IP rating:  
IP4X

Max. installation altitude:  
2000 metres



### Description

A range of 6 and 16 amp ceiling switch options plus a 50 amp DP flush mounted ceiling switch.

### Features

- Mounting blocks have an earth terminal rivetted into their bases
- 3190RC WHI has a retractive (momentary) switch action and can be wired as either pull to make or pull to break
- 3190RC WHI has a red pull cord
- Ceiling switch cords are 1.5m minimum length, except 3190RC WHI which is 2m
- 3164 WHI is fitted with mechanical OFF indicator
- 3164 has a full 3 mm contact gap when off
- 3164 may be surface mounted

### Dimensions (mm)

#### 3191/2 WHI

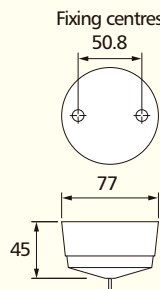

#### 3190 RC WHI

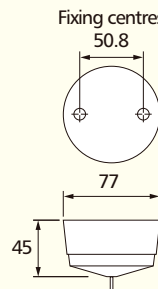

#### 3131 WHI

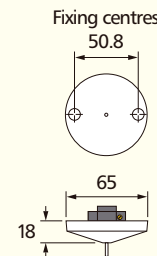

#### 3164 WHI

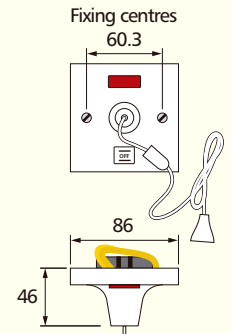

#### 3151 WHI

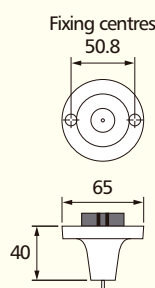

#### 2051 WHI

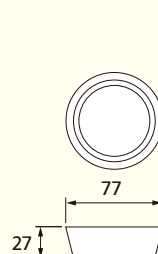

#### 2056 WHI

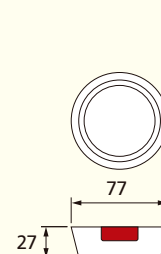

### Installation

MK ceiling accessories are safe for use in all normal lighting applications. Do not mount them where they may be subjected to excessive moisture or dampness.

### Wiring

Products must be installed in accordance with current IEE regulations. (BS 7671).

For a full range of corresponding products, see page 38 in the product selector.

## Ceiling Roses and Pendants

### Standards and approvals

Heat resistant lampholders comply with BS EN 61184: 1995 T2.

All ShockGuard lampholders comply with BS 5042 T2: 1987

Ceiling roses comply with BS 67: 1987

Pendant sets are supplied with heat resisting PVC insulated and sheathed flexible 0.75 two core circular cable complying with BS 6141: 1981

### Technical specification

#### Electrical

Lampholders and batten lampholders

Voltage rating:  
250V a.c.

Maximum rating:  
150 watts

Terminal capacity:  
Live, neutral & earth  
3 x 1.0mm<sup>2</sup>  
2 x 1.5mm<sup>2</sup>

Ceiling roses & base of pre-wired batten lampholders

Voltage rating:  
250V a.c.

Maximum rating:  
6 amps

Terminal capacity:  
Live, neutral & earth  
4 x 1.0mm<sup>2</sup>  
3 x 1.5mm<sup>2</sup>  
1 x 2.5mm<sup>2</sup>

#### Physical

Ambient operating temperature:  
-5°C to +40°C

IP rating:  
IP4X

Max. installation altitude:  
2000 metres

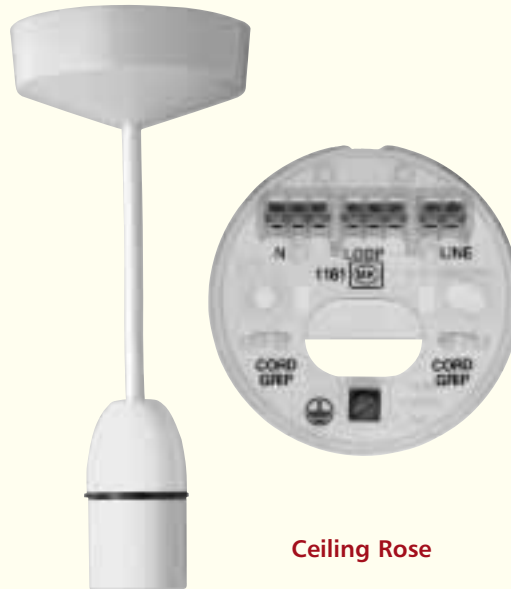

**Ceiling Rose**

### Dimensions (mm)

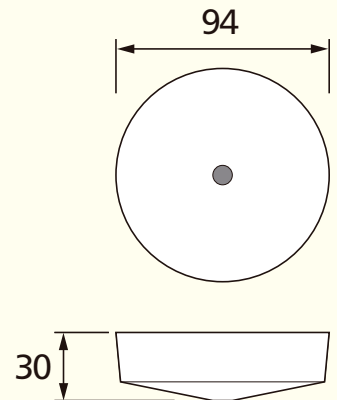

### Description

The range includes ShockGuard™ SG type lampholders, pendant sets, batten lampholders and ceiling roses.

### Features

#### ShockGuard™

- Automatically cuts off the power at the contacts as soon as the lamp is removed
- The power stays cut until a new lamp is slotted into place
- While there is no lamp in place there is no danger of electrocution

#### Ceiling roses

- Clear base and pre-cut aperture for ease of installation
- Clear markings
- Terminal layout allows cables to be cut to even length
- Earth terminal point used for easier cable access
- Halo available to give professional finish on damaged ceilings (for use with ceiling roses and pendant sets only)

## Lampholders and Shockguard type Lampholders

### Dimensions (mm)

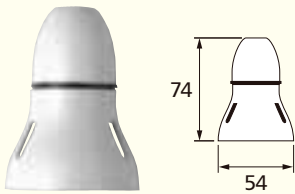

**Standard Lampholder with protective skirt**

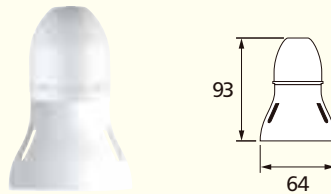

**SG Type Lampholder with protective skirt**

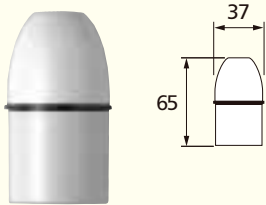

**Standard Lampholder**

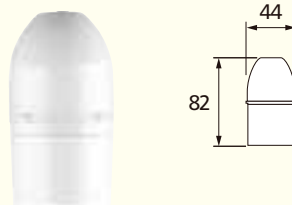

**SG Type Lampholder**

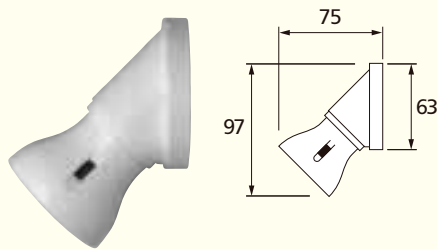

**Standard Angled Batten Lampholder**

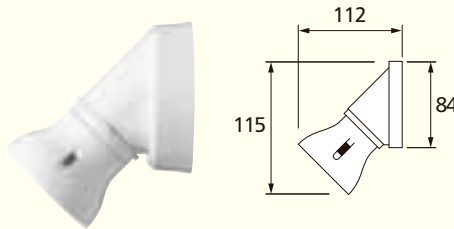

**SG Type Angled Batten Lampholder**

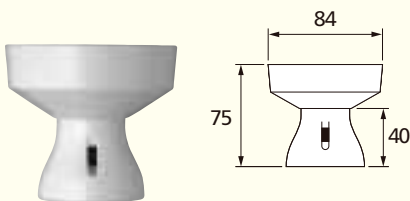

**Standard Batten Lampholder**

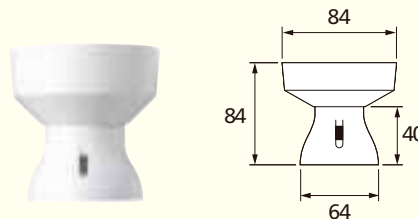

**SG Type Batten Lampholder**

### Heat Resistance

Two levels of heat resistance are nominated for lampholders but at different maximum working temperatures and the products must be identified by a different marking code.

Heat resistance	Max working temp
2 levels of heat resistance	Lamp cap temp 210°C marked BS 7895: 1997 and BS EN 61184 T2

### Lamp wattage rating

All MK lampholders comply with category T2 BS EN 61184. It is important to ensure that the wattage rating of the lamp used is not higher than that for which the particular shade or luminaire is designed. The maximum rating in watts is marked on all shades and luminaires that comply with the requirements of BS 4533: Part 101.

### Weight of fittings

Ceiling roses and pendant sets are suitable for fittings of up to 3 kg. Heavier fittings must be installed using independent support, e.g. ceiling hook.

### Angled batten lampholders

Can be mounted direct to the wall. The surface mounting patress (1179 WHI) may be used if more wiring space is required.

### Straight batten lampholders

Can be screwed direct to the ceiling but it must be ensured that it is fastened to a wooden joist. Integral Ceiling Rose included.

### Ceiling roses and pendant sets

Flush mounting to circular conduit boxes in accordance with BS 4568: Part 2.

### Installation

MK ceiling accessories are safe for use in all normal lighting applications. Do not mount them where they may be subjected to excessive moisture or dampness.

### Wiring

Products must be installed in accordance with current IEE regulations. (BS 7671).

## Low Energy Lighting

### Standards and approvals

BS EN 60928:1995 – Auxiliaries for lamps – a.c. supplied ballasts for tubular fluorescent lamps – General and safety requirements.

BS EN 60929: 1992 – a.c. supplied ballasts for tubular fluorescent lamps. Performance requirements.

BS EN 55015: 2001: Limits and methods of measurements of radio disturbance characteristics of electrical lighting and similar equipment.

BS EN 6100-3-2:2001 – Electromagnetic compatibility (EMC) limits for harmonic current emissions.

BS EN 61547: 1996 – Specification for equipment for general lighting purposes. EMC immunity requirements



### Technical specification

Lighting wattage	10W	13W
System wattage	11W	15W
Luminous flux	600 lm	900 lm
Mains current	60 mA	70 mA
Supply voltage: 230 – 240V		
Permissible voltage range a.c.: 176V – 254V		
Permissible voltage range d.c.: 176V – 254V		
Lamp start: warm start within 2 seconds		
Mains frequency: 0/50 – 60Hz		
Operating frequency: approx. 40KHz		
Power factor: 0.85 – 0.9		
Ambient temp. range: –20°C to +50°C		

Lamp can be operated on either sinusoidal a.c. voltage or d.c. voltage. The following table shows the Permissible voltage ranges and behaviour in response to overvoltage and undervoltage.

#### Permissible constant voltage range

a.c. voltage	198V – 254CV
d.c. voltage	176V* – 254V

#### Overvoltage protection

Continuous overvoltage (for approx. 24h)	up to 280V1
Behaviour on exceeding overvoltage limits	over 280V ECG fault possible

#### Behaviour at undervoltage

1. Voltage drop during operation	Damage to ECG possible at continuous undervoltage
2. Ignition at undervoltage	Below 198V lamp ignition unreliable: safety shutdown not triggered in the event of lamp fault

Polarity of supply	Not necessary, L and N are interchangeable
--------------------	--

\* Ignition must take place above 198V. The voltage may drop to 176V before lamp extinguishes.

### Features

- Simple wiring, quick and easy installation
- Simple entry into the market sector for high-value energy-saving pendants

### Comfort

- Flicker-free ignition
- Pleasant flicker-free light with no stroboscopic effects
- No flashing of faulty lamps
- Automatic restart after lamp replacement

### Economy

- 50% longer lamp life compared with conventional control gear (CCG/LLG) as result of preheat start

- Up to 25% reduction in input power compared with compact fluorescent lamps (CFLs) operated with conventional control gear
- 80% lower power consumption and 80% less heat than incandescent lamps, 10 times longer life than incandescent lamps

### Safety

- Safety shutdown of the power supply to defective and end-of-life lamps
- Complies with European standards for safety, performance and EMC (electromagnetic compatibility)
- Greater fire protection because control gear temperatures are lower

### Dimensions (mm)

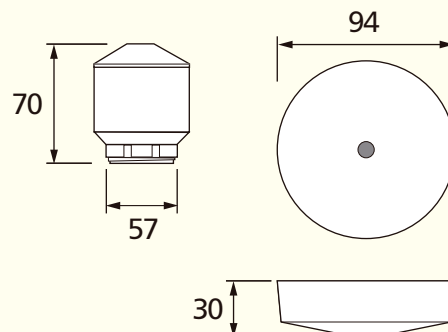

### Installation: Low Energy Lighting

Lamp: DULUX D/E 10, 13W, T/E 13W

Maximum load capacity of the bayonet lock cover-cap is 3kg when used with 0.75mm<sup>2</sup> PVC twin core cable. A standard M40 x 2.5 threaded ring is included to retain the shade.

#### Opening the cover cap

Insert a screwdriver in the small slot on the side (you will hear a slight click).

Turn the cover anti-clockwise.

#### Closing the cover cap

Turn anti-clockwise until you hear it click into place.

#### Connecting the mains cable through the central hole M10 x 1

The **strain relief** is effective when an H03 W H2-F cable is looped around the “hook” and fed out through the central hole in the cover cap.